

CTEK

# ***INSTALLATION MANUAL***

*DAISY CHAIN ETHERNET SWITCH KIT  
WITH CHARGESTORM® CONNECTED 2*

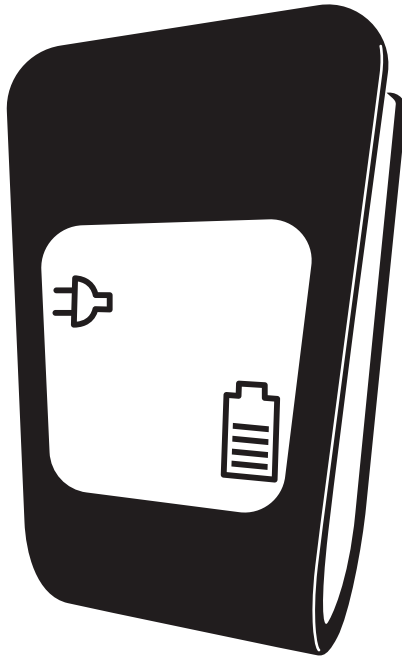

## Contents

Purpose.....	3
Safety .....	3
<b>National usage restrictions.....</b>	<b>3</b>
To prepare the installation.....	3
<b>Tools .....</b>	<b>4</b>
<b>Materials included .....</b>	<b>4</b>
<b>Materials not included .....</b>	<b>5</b>
<b>Overview of the installation .....</b>	<b>5</b>
To install the switch kit.....	6
To do a test of the power supply .....	6
To install the Ethernet cable .....	7
To recycle the product .....	7
References .....	7
Revisions.....	7
Copyright.....	7
CTEK E-Mobility warranty statement.....	8
<b>Limited warranty .....</b>	<b>8</b>
<b>Circumstances that will void the limited warranty .....</b>	<b>8</b>
<b>Additional information .....</b>	<b>8</b>

## Purpose

This manual explains how to install the daisy chain kit (art. no 40-467), to enable support for daisy chaining of power and ethernet connection for Chargestorm Connected series. This kit is compliant with pole mount kits 922-00018 and 922-00019.

## Safety

- Only an accredited electrician is allowed to perform the installation described in this document.
- Read and obey the instructions in this document before installation and operation of the product.
- Installation must fulfil local safety regulations.
- Use safety shoes during the installation.

## National usage restrictions

Some countries, states or provinces have other electrical codes and standards than stated in this manual. The installation and usage of the product shall follow local regulations. The product is intended for use by general public. The product is intended for locations with both restricted access and non-restricted access.

This product is only allowed for use in the following regions: CZ, DE, DK, GR, ES, FI, FR, IS, NL, NO, PL, SE, UK, AT, BE, CY, IE, LU and MT.

## To prepare the installation

- Prepare and mount internal power wires and the ethernet cable of the Chargestorm Connected series before attaching to the daisy chain kit.
- Make sure that the holes are drilled correctly. Refer to the manual for Chargestorm Connected 2.

EN

## Tools

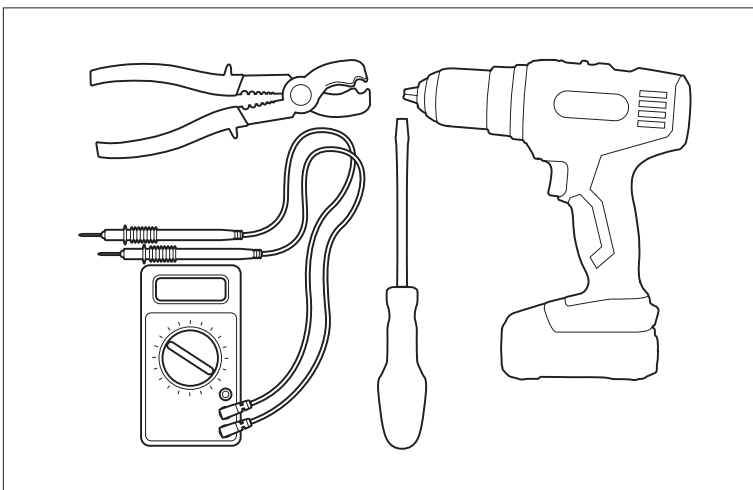

## Materials included

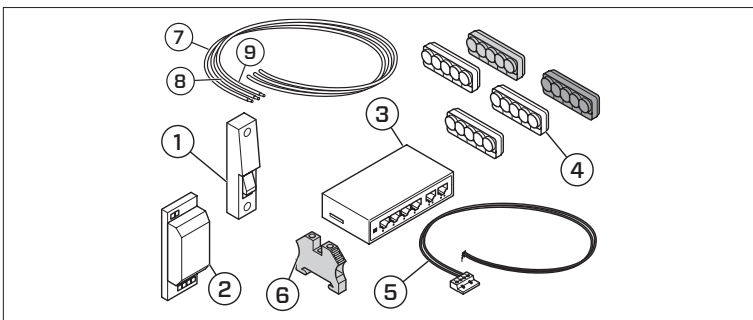

1. Fuse
2. Power supply
3. Ethernet switch
4. Terminal blocks , L1-L3, N, PE
5. Power supply cable switch
6. DIN-mounted terminal block
7. Ground cable from terminal blocks to the power supply unit (6mm<sup>2</sup>)
8. Phase cable from the fuse to the power supply unit (2.5mm<sup>2</sup>)
9. Neutral cable from the fuse to the power supply (2.5mm<sup>2</sup>)

## Materials not included

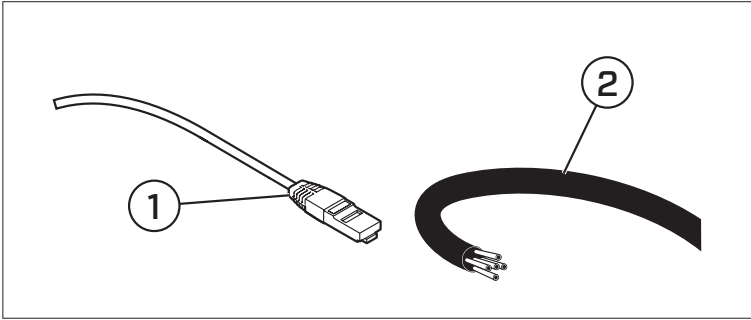

1. Ethernet cable
2. Main input cable to the terminal blocks.

## Overview of the installation

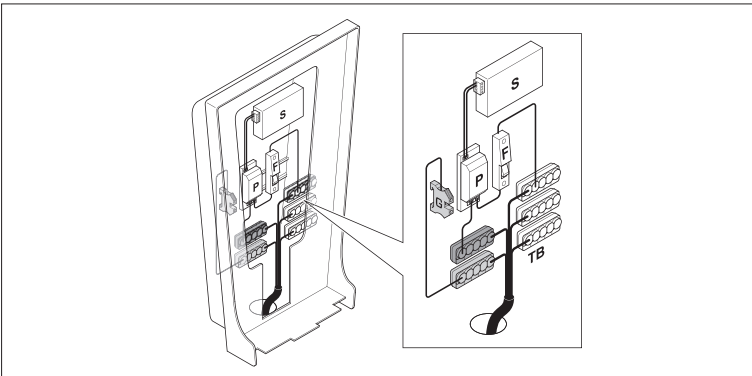

- |    |                       |     |                                |
|----|-----------------------|-----|--------------------------------|
| S. | Ethernet switch       | F.  | Fuse                           |
| P. | Power supply          | TB. | Terminal blocks , L1-L3, N, PE |
| G. | Ground terminal block |     |                                |

## To install the switch kit

1.

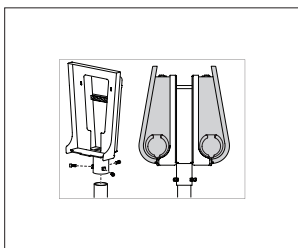

2.

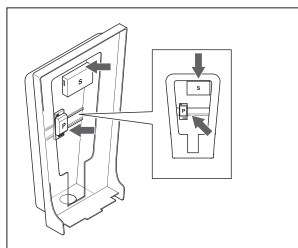

3.

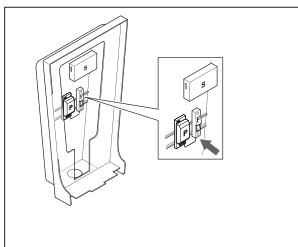

4.

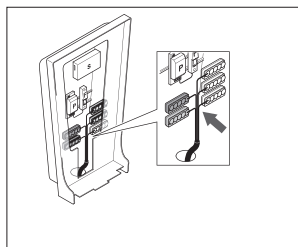

5.

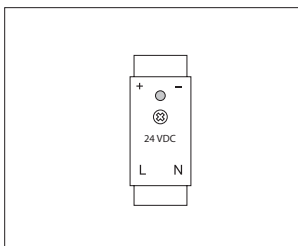

6.

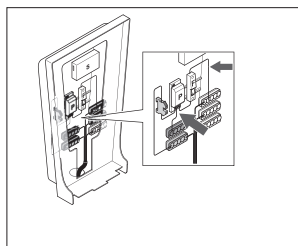

7.

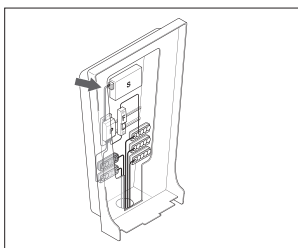

EN

## To do a test of the power supply

1.

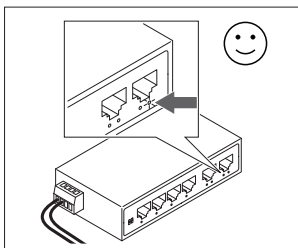

2.

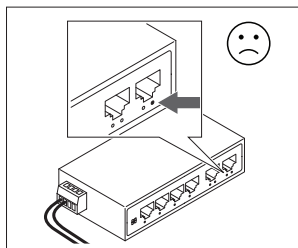

## To install the Ethernet cable

1.

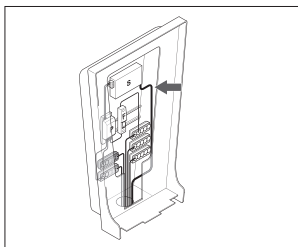

2.

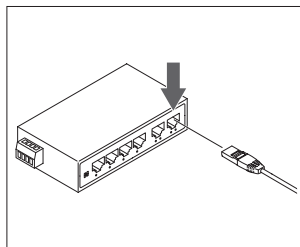

3.

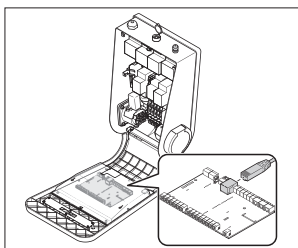

## To install the power cables in Chargestorm Connected

1.

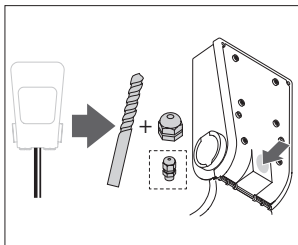

2.

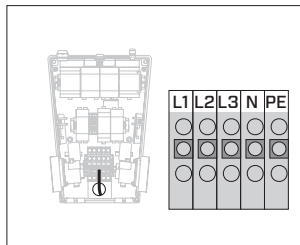

EN

## To recycle the product

The product must be recycled as electronic equipment. Follow the local requirements for recycling of electronic equipment.

## References

1. CHARGESTORM® CONNECTED 2 Installation manual (Pd\_IM\_0011).
2. 6 ports Fast Unmanaged Industrial PoE Switch Manual.

## Revisions

The descriptions, information and specifications contained in this manual were in effect at printing. To make sure that the maintenance instructions are complete and up to date, always read the manual published on our website.

## Copyright

These instructions are delivered “as is” and contain content that can change without prior notice. CTEK E-Mobility AB does not guarantee that everything is correct in the instructions. CTEK E-Mobility AB is not responsible for faults or incidents or damage that is caused by not following the instructions in this manual.

© Copyright CTEK E-Mobility AB 2020. All rights restricted. Copying, adaption or translation of these instructions are strictly forbidden without written approval by CTEK E-Mobility AB, except what is regulated by copyright laws. CTEK E-Mobility warranty statement

EN

## Limited warranty

CTEK issues a limited warranty to the original purchaser of the product. Depending on the product, the limited warranty period will vary. The limited warranty is not transferable. The warranty applies to manufacturing faults and material defects. The warranty is void if the product has been handled carelessly or repaired by anyone other than CTEK or its authorized representatives. CTEK makes no warranty other than this limited warranty and is not liable for any other costs other than those mentioned above, i.e. no consequential damages. Moreover, CTEK is not obligated to any other warranty other than this warranty.

## Circumstances that will void the limited warranty

If the seal of the product is broken, purposely damaged, or in any way modified or altered; including cables, electronics, mechanics or other parts of the product; products that have been repaired by anyone other than CTEK or its authorized representatives; products that have been subject to the use of supplies and accessories other than those approved in writing or supplied by CTEK; improper use or non-compliance with installation, commissioning, operation or maintenance instructions (i.e. not according to the operation and installation manual); unauthorized modifications, changes or attempted repairs; vandalism, destruction through external influence and/or persons/animals; failure to observe applicable safety standards and regulations; faults caused by fire, water, snow, moisture, or other liquids except as specified for normal use; products where the serial number is defaced, altered or removed; any utilization of a product that is inconsistent with either the design of the product or the way CTEK intended the product to be used; any installation and/or modifications that prevent normal service of the product; normal wear and tear and cosmetic damage such as, but not limited to,



corrosion, scratches, dents, rust, stains, non-functional parts such as, but not limited to, plastics and finishes; damage, fault, failure and/or imperfection caused by abuse, tampering, illegal use, negligence, prolonged use or operation; or faults in any other way caused by the customer/retailer/user.

## Additional information

CTEK makes no other warranty than as set out herein and CTEK shall in no event be liable for any indirect or consequential damages. The faulty product shall be returned with the receipt to the retailer/place of purchase together with a fault description. Goods returned to CTEK will be at CTEK's discretion and only valid with an approved Return Material Authorisation (RMA) Reference Number issued by CTEK to the purchaser. Products sent directly to CTEK without an RMA will be returned to the sender at the sender's cost. The warranty period for a product is stated in the applicable product user manual supplied with the product. The warranty is only valid if the warranty period has not expired. If the warranty claim of a faulty product is not approved by CTEK, the product will be returned only if the sender explicitly so requests. The customer/retailer/place of purchase will pay the freight. Faulty products will be repaired, or replaced with an exchangeable product, and returned at CTEK's cost. If the warranty period has expired, the product will be returned without further investigation at the cost of the customer/retailer/place of purchase. Faulty products will be scrapped by CTEK if deemed not repairable. CTEK reserves the right to vary, modify or change the terms and conditions herein due to change(s) in availability of services, products and/or spare parts, or for the purpose of complying with applicable policies, rules, regulations and law, without notice.

EN

50024293A

CTEK

*WWW.CTEKEMOBILITY.COM*

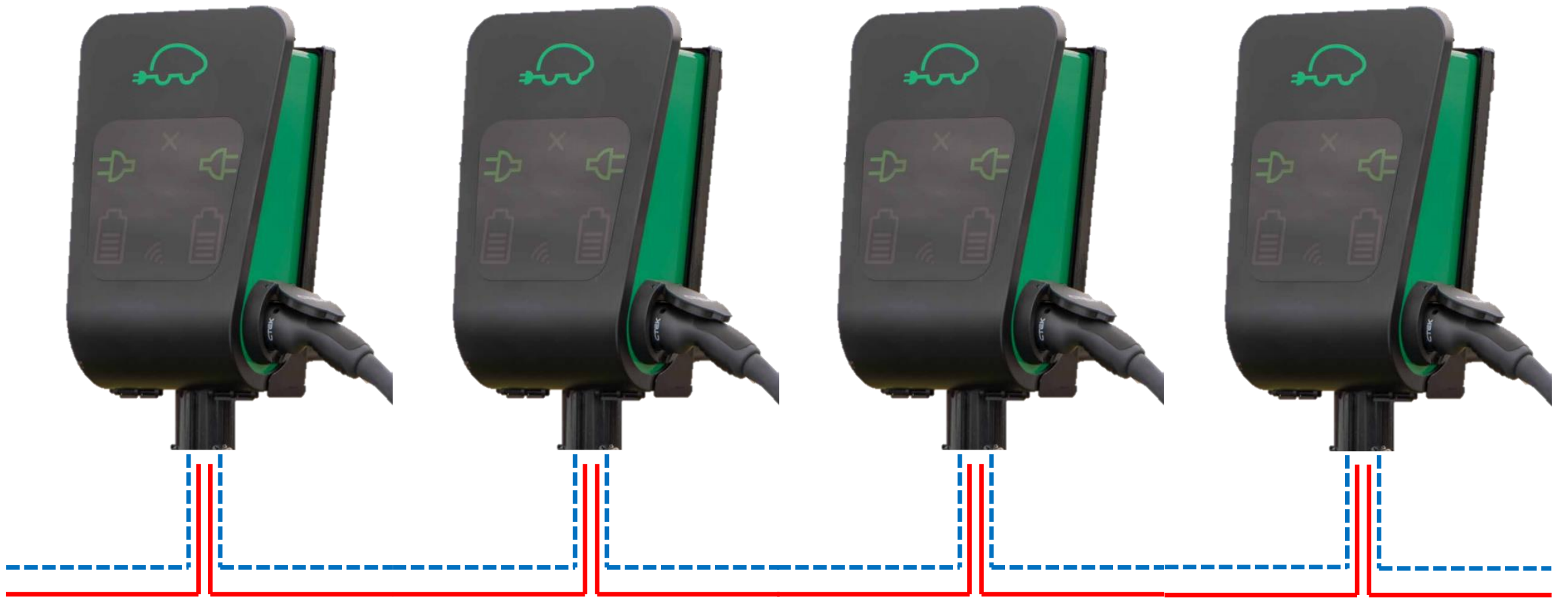

1P/3P  
Power

LAN  
connection



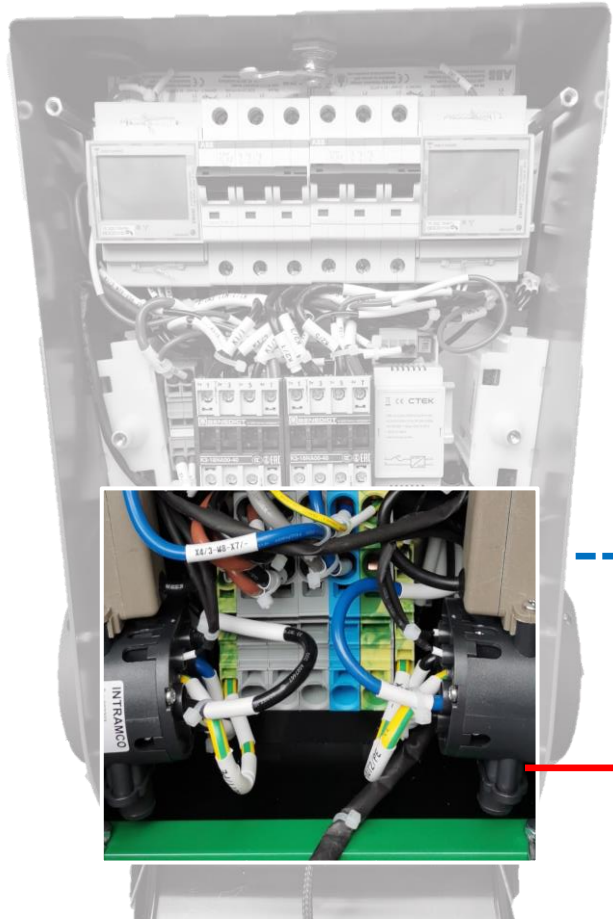

1P/3P Power

LAN connection

